

XCT35汽车起重机 / Truck Crane

技术规格书

Basic technical specification

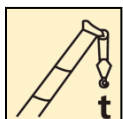

35 t

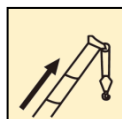

42 m

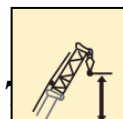

56.8m



目录

Content

目录 Content	
尺寸参数 Dimensions	2
技术规格 Product Specifications	3-6
重量/作业速度 Weight / Working speeds	7
臂架组合方案 Boom / Jib combinations	8
主臂 Boom	9-10
副臂 Jib	11-12
符号标识 Description of symbols	13
注意事项 Notes	14

尺寸参数 Dimensions

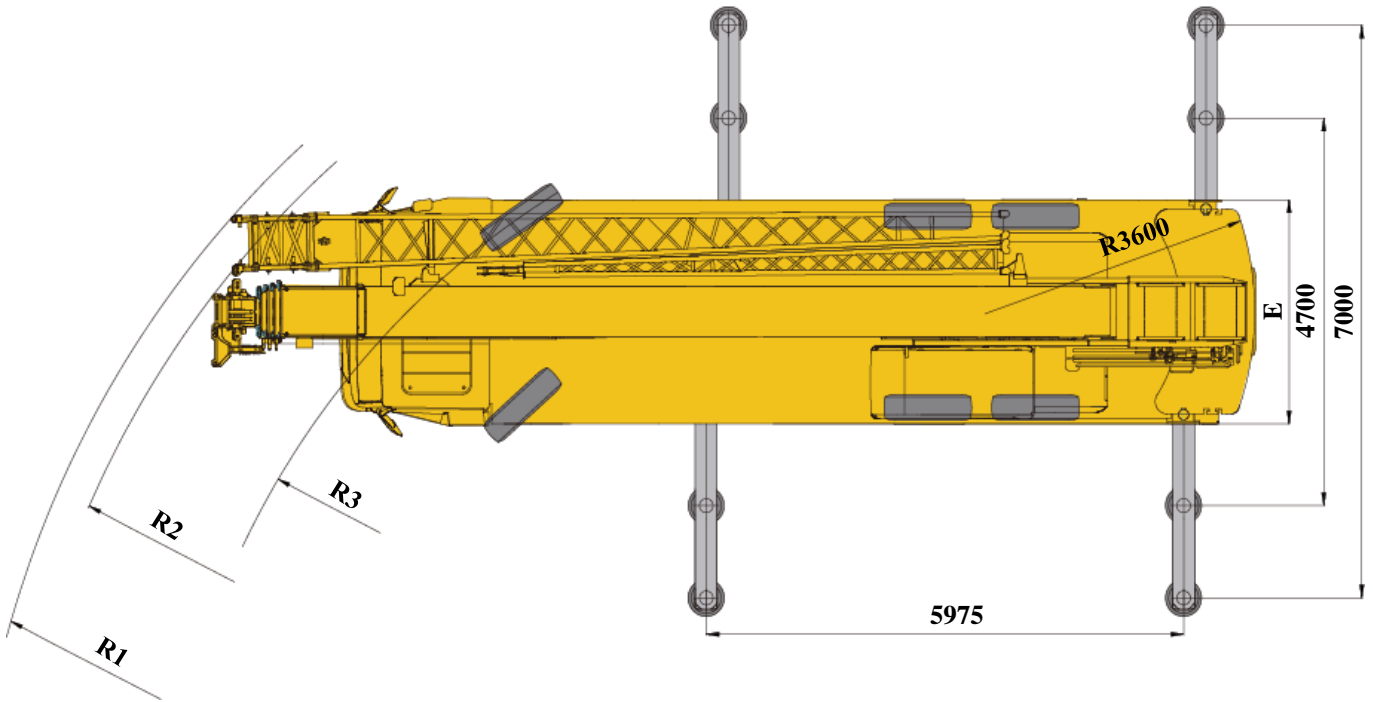
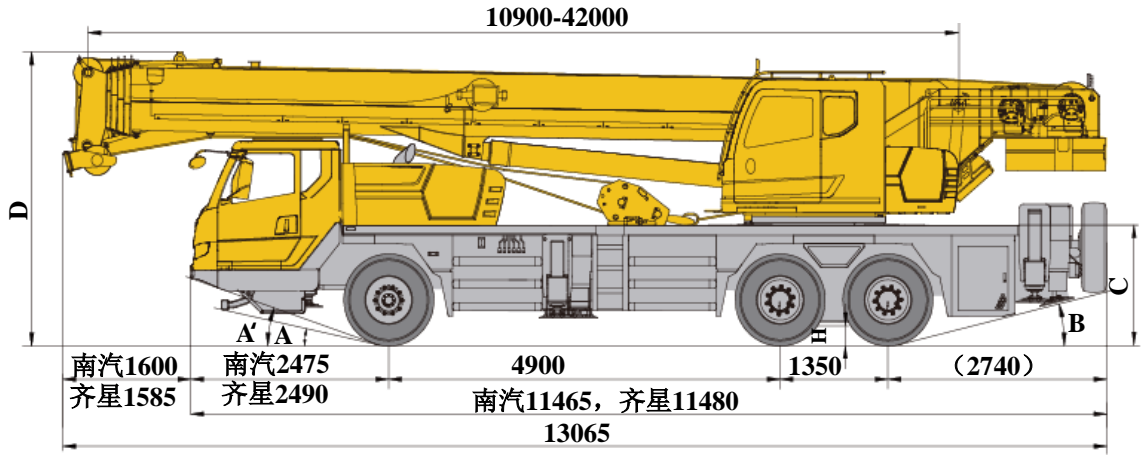



	A	A'	B	C	D	E	R1	R2	R3	H
315/80 R22.5	12°	18°/19°	13.5°	1417	3540	2750	14200	13750	11000	260

技术规格

Technical specifications

	底盘
车架	徐工设计、制造，全覆盖式走台板，防扭转箱型结构，高强度钢材制造。
支腿	4支腿；纵向H形布置，操作杆控制液压动作；可由底盘任一侧同时或单独控制各支腿的动作，设有水平仪；带第五支腿；且垂直支腿带有液压双向锁 支脚盘尺寸：450mm×450mm 最大起重量时支腿反力：402.68KN。
发动机	SC9DF300.2Q5，直列六缸水冷电控柴油发动机，上柴，额定功率221kW/1900rpm，最大扭矩1400Nm/1400rpm，国V排放标准。 燃油箱容积：220L。
变速箱	采用陕齿9JS135TA机械式变速箱，手动远距离软轴操纵，全同步器；9个前进档，1个倒档，工作稳定、可靠。
车桥	3桥底盘，2、3桥驱动，1桥转向，高强度承载桥，引进国外先进技术设计，名牌厂家制造，性能可靠。 第一桥：单胎，转向不驱动； 第二桥：双胎，驱动不转向； 第三桥：双胎，驱动不转向。
悬挂	前悬架采用少片变截面钢板弹簧，自重轻，噪音低，舒适性好；后悬架采用橡胶悬架，V型推力杆，自重轻，定位效果好，免维护，维修方便。
轮胎	315/80R22.5-22PR，无内胎轮胎，重量轻，散热好，行驶噪音低，承载力强，使用寿命长。
制动	行车制动：脚踏板操纵的双回路气压制动。一轴为盘式制动器，二、三轴为鼓式制动器。第一回路作用于一轴车轮上，第二回路作用于二、三轴车轮上。 驻车制动：放气制动，作用于二、三轴上，通过各轴上的弹簧储能气室起作用。 辅助制动：发动机排气制动+发动机缸内缓速制动。
转向	1桥机械转向+液压助力。
驾驶室	新型复合结构全宽驾驶室，全封闭、装备豪华舒适。性能上：优越的密封性和防腐蚀、防震设计；配置大视野的前挡风安全玻璃、电动后视镜，电控洗涤器，电子门窗升降器，带有除霜风挡的室内空气加热器，冷暖空调，收放音机等。主驾采用机械减震座椅，副驾采用简易卧铺，满足人员的操纵舒适性及乘

	底盘
驾驶室	坐方便性。造型上：型面分割协调匀称，特征明显，现代感强。凹凸的型面造型增强驾驶室的层次，更加考究的门锁把手、踏梯涂装设计。侧窗后部及A柱装饰采用使造型更显简洁的黑色涂装。犀利的前大灯与进气格栅提升了驾驶室稳重，大气，动感的气质。
电气系统	24V直流电源，负极搭铁，串联12V的蓄电池2个，底盘照明系统按中国道路交通标准，包括日间行车灯、可调节前大灯，前后雾灯，倒车灯等；发电机输出电压 $28.5 \pm 0.3V$ ，输出电流70A。

	上车
结构	徐工设计、制造，高强度钢材制造。
液压系统	发动机驱动变量柱塞泵，用于起升、变幅、伸缩。负载敏感式比例多路换向阀，带有抗冲击阀、防气蚀阀；风冷式液压油散热器；液压油箱容积：490L
操纵方式	液控先导操纵系统，由左右2个操纵手柄控制由液压泵和比例阀进行液压先导式控制起重机的全部动作
主起升机构	液压控制调速，装有双折线绳槽卷筒，由液压马达通过行星齿轮减速器驱动，内置常闭式制动器并带有平衡阀；
副起升机构	液压控制调速，装有双折线绳槽卷筒，由液压马达通过行星齿轮减速器驱动，内置常闭式制动器并带有平衡阀；
回转机构	四点接触球式回转支承，由液压马达驱动行星齿轮回转机构减速器驱动，可连续回转 360° ；具有动力控制或自由回转的功能，可无级调速；回转杆设有鸣响开关；
变幅机构	单支双作用前置液压变幅油缸，带有平衡阀
操纵室	新型钢制操纵室，装有无视野死角的前景窗，安全玻璃，车窗装有遮阳板，推拉式车门，座椅靠背可倾斜定位，操纵杆安装在座椅两侧的扶手台上；带推拉踏板；前窗顶窗装有雨刮器；标配单冷空调；
安全装置	液压平衡阀；液压溢流阀；液压双向锁；力矩限制器；三圈保护器，防止钢丝绳过放；臂头设置高度限位，防止钢丝绳过卷；三色报警灯；

技术规格

Technical specifications



臂架系统

主臂	5节，“U”形截面的筒形焊接结构。双缸绳排伸缩机构 主臂长度：10.9m~42m。
臂端单滑轮	单滑轮，安装在主臂顶端用于单股钢丝绳起重作业，起重性能与9.2m副臂0°安装角时的起重性能，但最大起重量不超过4t
固定副臂	2节桁架式焊接结构，具有0°、15°、30°三种固定副臂安装角 固定副臂长度：9.2m~16m

选装配置

安全装置	风速仪；卷扬监视装置；上车水平仪；
发动机	SC9DF290Q3，直列六缸水冷电控柴油发动机，上柴，额定功率213kW/2200rpm，最大扭矩1200Nm/1400rpm，国III排放标准。

产品各部件明细如上所述，具体部件明细请参照产品报价单

技术规格

Technical specifications

 Chassis	
Frame	Designed and manufactured by XCMG, with all covered walking surface, anti-torsion box structure and optimal load-bearing structure design, made of imported high strength steel.
Outrigger	4 outriggers, H-shaped arrangement, lateral and vertical outrigger controlled by the hydraulic control. Control levers are located on both sides of the chassis, with a luminous level gauge equipped, with the fifth jack, and the vertical outrigger has two-way hydraulic lock. Outrigger float dimension: 450mm×450mm Max. outrigger reaction force: 402.68KN.
Engine	SC9DF300.2Q5, in-line six-cylinder water-cooled EFI diesel engine, manufactured by Shanghai Diesel Engine Co., Ltd., rated power 221kW /1900rpm, max. torque 1400Nm / 1400rpm, the national V emission standards. Fuel tank capacity : 220L.
Gearbox	FAST manually mechanical control , 9-speed available, synchronizer is equipped. with 9 forward gears and 1 reverse gears available,Stable and reliable work.
Axles	High strength axle with reliable performance from Meritor. 1st axle for Steering,2nd axle and 3rd axle for driving.
Suspension	Front suspension: variable cross-section leaf spring suspension, light weight, low noise and good comfort; Rear suspension: V-type thrust rod structure,light weight, good positioning effect, convenient maintenance.
Tires	315/80R22.5-22PR , tubeless tire, light weight, good heat dissipation, low noise, strong bearing capacity, long service life.
Brakes	Driving brake: double circuit pneumatic brake operated by pedal. The first axle is disc brake, the second and third are drum brake. The first loop acts on the first axle wheel, the second loop acts on the wheel of the second and third axles. Parking brake: exhaust brake, acting on the sceond and third axles, with the energy storage gas chamber is acted by the spring on each axle. Auxiliary brake: engine exhaust brake and engine cylinder slow braking.
Steering	Mechanically steering mechanism of the first axle with hydraulic power assisted.
Cab	A new type of composite structure ,width cab, fully enclosed, equipped luxurious and comfortable. Performance: superior tightness and anticorrosion, shockproof; the front windshield glass electric rearview mirror, large electronic configuration scrubbers, electric windows lifter indoor air heater defrosting windshield, air conditioner, radio etc.. The main driver adopts mechanical shock absorption seat, and the auxiliary driver adopts

Chassis	
Cab	simple sleeper, which can satisfy the comfort of the operator and the convenience of riding. Modelling: surface segmentation coordination , symmetry, obvious characteristics, modern. The concave and convex surface modeling enhances the cab's gradation, and the more exquisite door lock handle and ladder painting design. The rear window and the A column are decorated with black paint which makes the modeling more concise. Sharp headlights and intake grille to enhance the cab steady, handsome innervation.
Electrical system	24V DC, two sets of battery. Generator: 28.5±0.3V-70 A

 Superstructure	
Frame	Designed and manufactured by XCMG; made of high-strength steel
Hydraulic system	Quadruple pump is driven by the engine. constant delivery pump is used for lifting, elevating, telescoping and slewing; Load sensitive proportional multi-way change valve, impact-resistant valve and anti-cavitation corrosion valve are equipped. Air-cooled hydraulic oil radiator; Volume of hydraulic oil tank: 490L
Operating mode	Hydraulic pilot control of all crane movements using two control levers. All crane movements are controlled by hydraulic pump and proportional valve.
Main winch system	Hydraulic controlled speed regulation, groove drum is equipped, driven by hydraulic motor through planetary gear reducer, and built-in normally closed brake and counterbalance valve are available.
Auxiliary winch system	Hydraulic controlled speed regulation, groove drum is equipped, driven by hydraulic motor through planetary gear reducer, and built-in normally closed brake and counterbalance valve are available.
Slewing system	Four-point ball contact slewing ring. Slewing system is driven by hydraulic motor, with planetary gear reducer, for 360° continuous rotation, stepless slewing speed regulation is available. Horn button is equipped on the control lever.
Elevating System	Single-supported double acting front-mounted hydraulic elevating cylinder, with balance valve equipped.
Operator's cab	New fully-enclosed steel tiltable cab with a full-view front window. Safety glass and sun shield are used for windows. Wipers are fitted for the windshield and roof window. The cab features a new ergonomic seat design with backrest adjustment and armrests with joysticks fitted. A sliding door and a pull-out step are available. Air conditioner are available. . Fire extinguisher 2kg
Safety devices	Hydraulic balance valve; Hydraulic relief valve; Double-way hydraulic valve; LMI; spring aligning device for joystick; Lowering limiter for preventing wire rope from over-releasing; Anti-two block at boom head for preventing wire rope from over-winding; tri-color warning lamp.

技术规格

Technical specifications



Boom system

Boom	5-section, U-shape cross section, welding structure. Boom length:10.9m ~ 42m.
Single top	Single top is installed on the top of main boom, for single wire rope hoist. Its lifting performance is the same as that for jib(9.2m), with 0° jib offset angles.
Jib	2-section, Lattice jib, welded structure. Three offset angles of 0° , 15° and 30° . Fixed jib length: 9.2m~16m

Additional equipment

Safety devices Anemometer, winch monitor device ; level gauge.

Additional equipment

Safety devices	Anemometer, winch monitor device ; level gauge.
Engine	SC9DF290.Q3, in-line six-cylinder water-cooled EFI diesel engine, manufactured by Shanghai Diesel Engine Co., Ltd., rated power 213kW /2200rpm, max. torque 1200Nm / 1400rpm, the national III emission standards.

Product parts details As mentioned above, please refer to the product quotation for specific parts.

重量 Weight





车桥 Axle	1	2	3	总重量 Total weight
t	9	13	13	35







吊钩 Hook	倍率 No. of lines	吊钩重量 Weight kg	吊钩尺寸 Dimensions mm	备注 Remarks
35t	8	360	389×504×1362	单钩 Single hook , 标配 Standard
5t	1	100	300×300×535	单钩 Single hook , 标配 Standard

作业速度 Working speeds



		
315/80R22.5	3 ~ 90 km/h	42%



作业机构 Drive	作业速度 Working speed	最大单绳拉力 Max. single line pull	钢丝绳直径/长度 Rope diameter/ length
	0-130 m/min, 单绳, 第四层 m/min, single line, 4th layer	46.9 kN	18 mm/180 m
	0-130 m/min, 单绳, 第四层 m/min, single line, 4th layer	46.9 kN	18 mm/125 m
	0-2 r/min		
	从-2°抬起至80°约40s Approx. 40s for boom elevation from -2° to 80°		
	从10.9m伸出至42m约80s Approx. 80s for boom extension from 10.9m to 42m		

臂架组合方案

Boom / Jib combinations



主臂
Telescopic boom

T : 10.9~42m

副臂
Jib

T : 10.9~42m
J : 9.2~16m

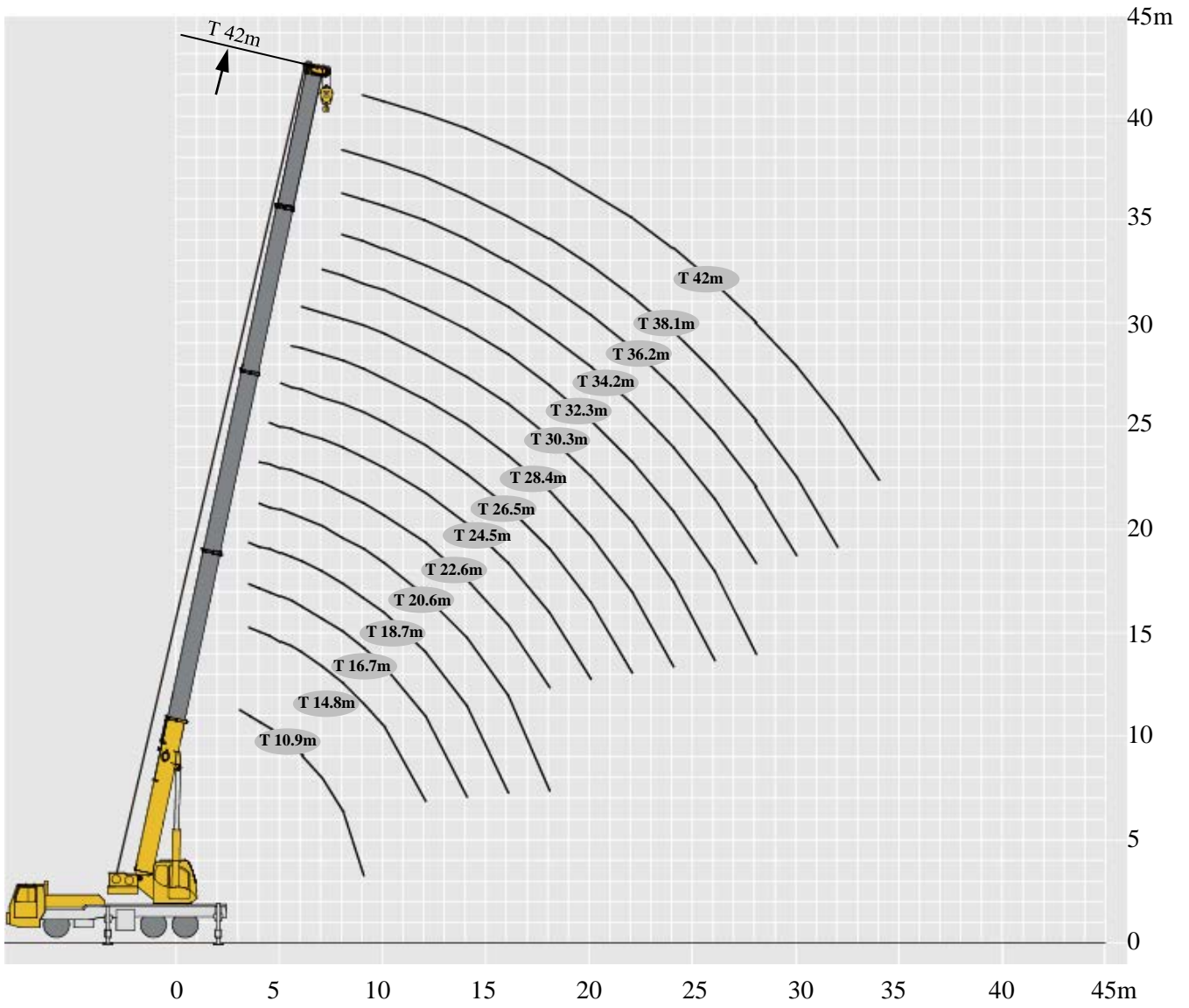

起重性能表

Lifting capacities

T 10.9~42m

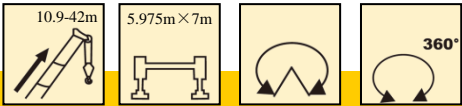

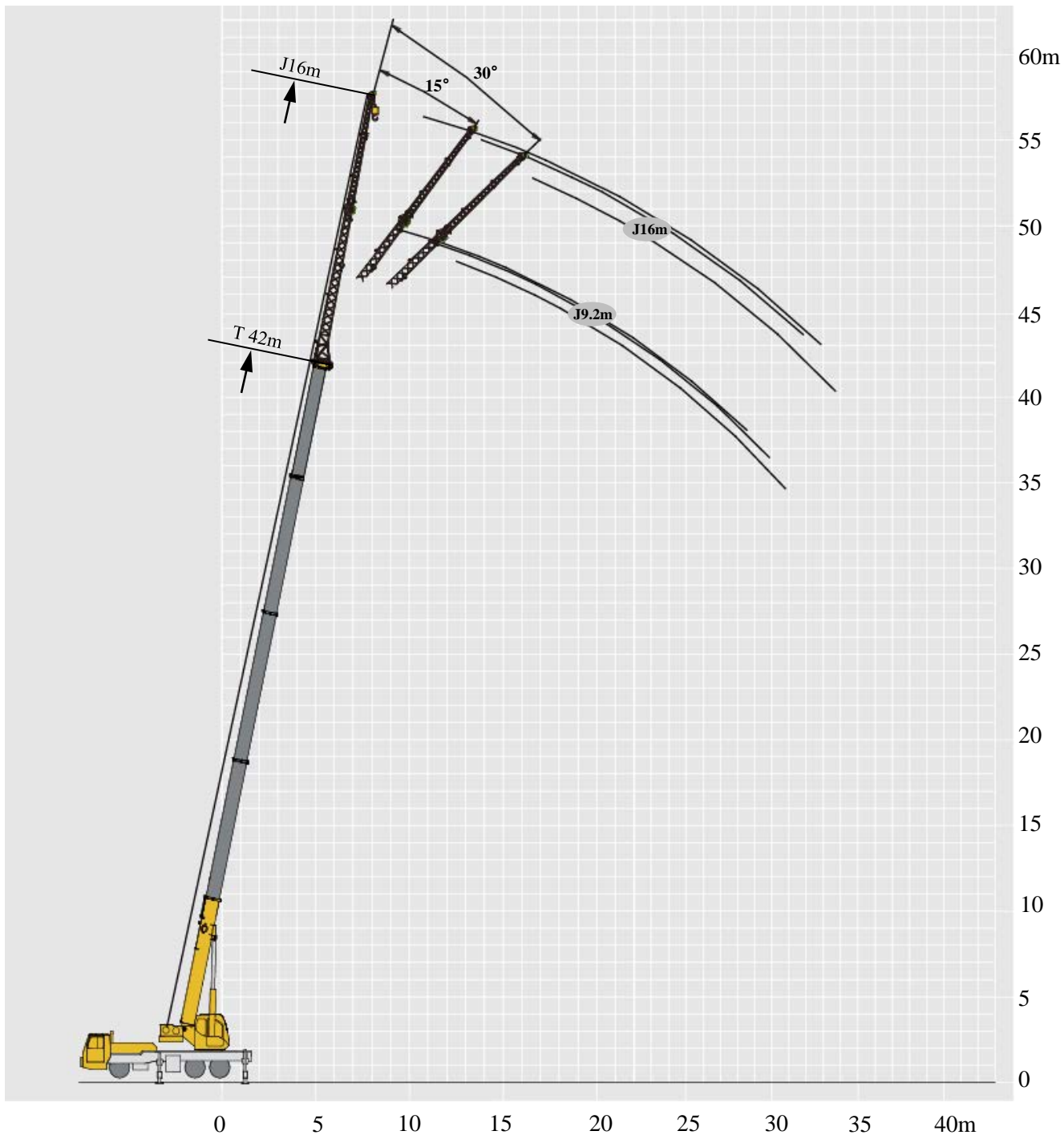

	10.9m	14.8 m	18.7m	24.5m	30.3 m	36.2m	42.0m	
3	35000							3
3.5	35000	34000	26500					3.5
4	34000	31000	26000					4
4.5	31000	29000	25000	19000				4.5
5	28500	27000	24000	18500				5
5.5	26500	24500	23000	17500				5.5
6	24000	23000	22200	16500	14000			6
7	20000	19000	19750	15000	13200	10000		7
8	15500	16400	16200	14000	12100	9400		8
9	12200	13100	12900	13000	11200	8800	7300	9
10		10800	10500	11500	10300	8300	6600	10
12		7500	7200	8200	8700	7200	6000	12
14			5200	6000	6500	6500	5300	14
16			3700	4600	5000	5350	5300	16
18				3500	3900	4250	4800	18
20				2600	3100	3400	3600	20
22					2400	2700	2900	22
24					1800	2100	2350	24
26					1400	1650	1900	26
28						1250	1500	28
30						950	1200	30
32							900	32
34							650	34



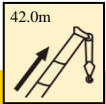
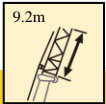
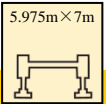

起重性能表

Lifting capacities

T 42m

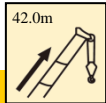
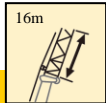
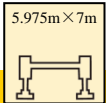
	    			
	0°	15°	30°	
78	4000	2500	2100	78
75	3500	2200	2000	75
72	3200	2000	1900	72
70	3000	1900	1800	70
65	2500	1800	1700	65
60	1500	1200	1100	60
55	900	800	700	55
50	600	500	400	50

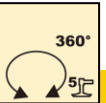
	    			
	0°	15°	30°	
78	2100	1400	1100	78
75	2000	1200	1000	75
72	1800	1100	900	72
70	1700	1000	800	70
65	1400	800	700	65
60	1000	700	600	60
55	600	500	400	55
50	400			50

符号标识

Description of symbols

常规标识

General symbols

	上车 Superstructure		底盘 Chassis
	起重能力 lifting capacity		车桥 Axle
	吊臂长度 Boom length		行驶速度 Driving speed
	工作幅度 Radius		爬坡能力 Gradability
	吊臂仰角 Boom position		轮胎 Tyres
	主臂起升高度 Hoist height with Boom		支腿 Outriggers
	固定副臂长度 Fixed jib length		使用第五支腿360°全回转 360° rotation with 5th jack
	副臂安装角 Jib offset angle		不使用第五支腿侧后方作业 Over side or over rear of the crane
	副臂起升高度 Hoist height with jib		
	吊钩 Hook block		
	卷扬 Winch		

注意事项

Notes

1. 表中额定总起重量值，是在平整的坚固地面上本起重机能够保证的最大总起重量，包括吊钩和吊具的重量，所以为了估算重物重量，必须减去上述的装置重量。

2. 表中的工作幅度为起吊重物离地时起重物到起重机回转轴线的水平距离，是包括起重臂变形量在内的实际值，因而起吊前应考虑起重臂变形量。

3. 只允许在5级(瞬时风速14.1m/s，风压125N/m²)风以下进行作业。

4. 吊重前操作者必须对物体的重量和工作范围了解后选择合适的作业工况，严禁超出表中的数值。幅度及臂长在相邻两个数值之间时，应依据两个数值中较小值确定起重作业。

5. 应按主臂仰角范围作业，即使是空载，也不应使主臂仰角处于范围外，谨防整机倾翻。

6. 表中的主臂长度应要按照每节臂的伸缩要求进行伸出。

1. The total rated loads given in the rated load charts are the maximum lifting capacity when the crane is set up on firm and level ground, which includes the weight of the hook block and slings. The weight of above-mentioned devices should be deducted to correctly calculate the load weight.

2. The working radius shown in the rated load charts is the radius when the load is lifted off the ground, and it is the actual value including loaded boom deflection.

3. A lifting operation is permissible only when the wind force is below grade 5 (instantaneous wind speed is 14.1 m/s, wind pressure is 125 N/m²).

4. Before beginning lifting operation, the operator should know the weight of the load to be lifted and its working range, and then select proper working conditions. Never operate the crane beyond the limit shown in the chart. Use the lower value from the chart when the boom length or working radius is between the range of values.

5. Observe the boom angle limit. Never operate the crane with the boom angle beyond the recommended limit even if a load is not being carried. Otherwise, the crane will tip.

6. The boom length given in the rated load charts should accord with the telescoping code of boom sections .